

TPW Prüfzentrum

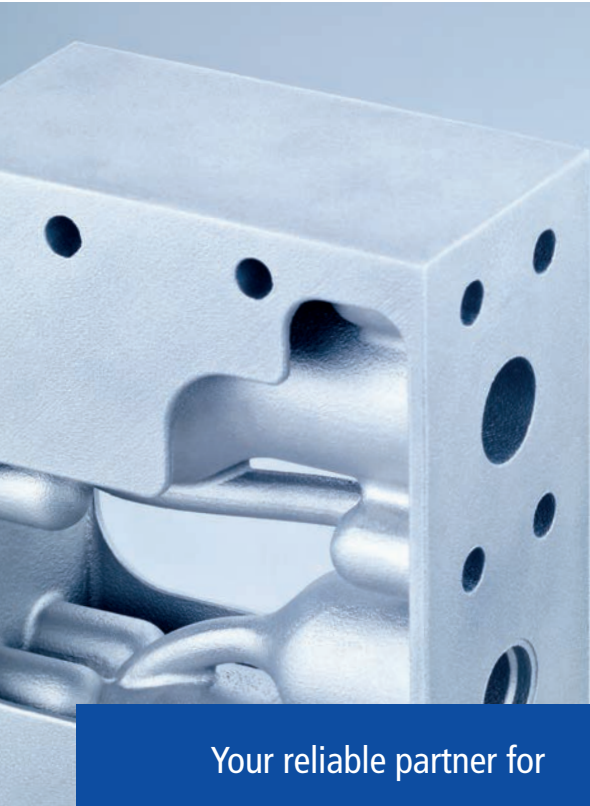

Picture: SOLIDTEQ GmbH

Your reliable partner for

Industrial Computed Tomography

Quality inspection for
additively manufactured parts

www.werkstoffpruefung.de



Examination of powder quality

By using high-resolution CT imaging, contaminations and pores in the raw powder substrate that is used for additive manufacturing can be detected.

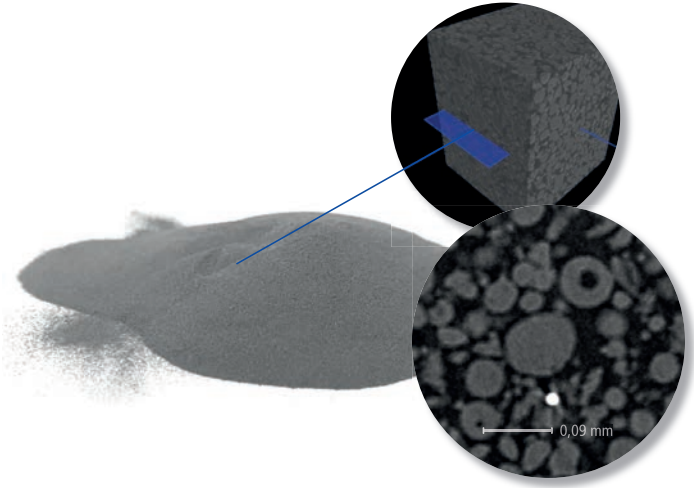

Grain sizes within a powder sample are automatically determined, quantified, and statistically analysed.

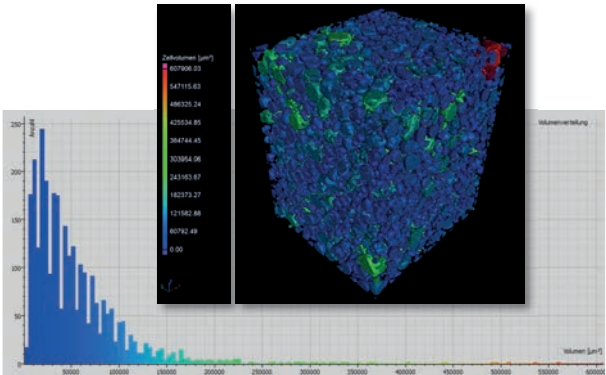

Defect recognition

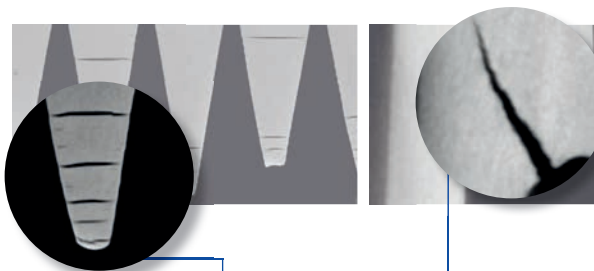

Voids, such as **delaminations**, **cracks**, pores, or inclusions can be visualized

Your personal contact:

Dr. Thomas Kleinteich

X-ray inspections and Computed Tomography
Level III RT according to DIN EN ISO 9712

Tel.: +49 2131 6655 266

Email: ct@werkstoffpruefung.de

CT inspection of an additively manufactured sample

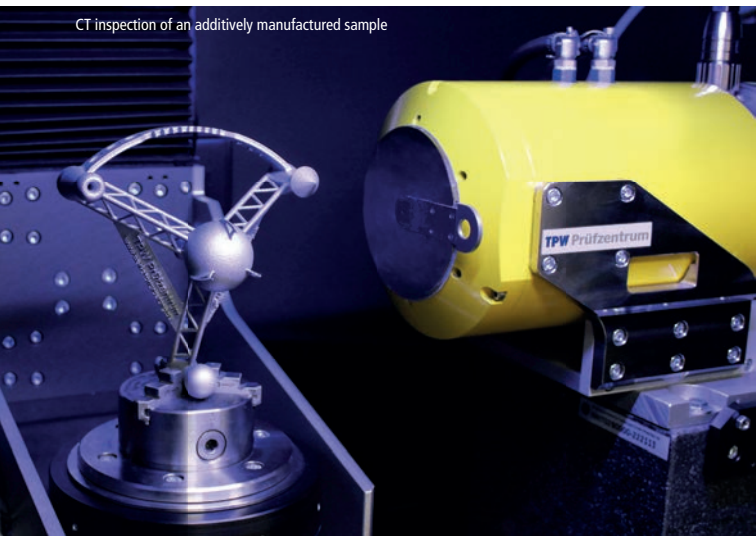

Actual-Nominal comparison

False color coded comparison between the nominal CAD-geometry and the actual part geometry over its entire surface.

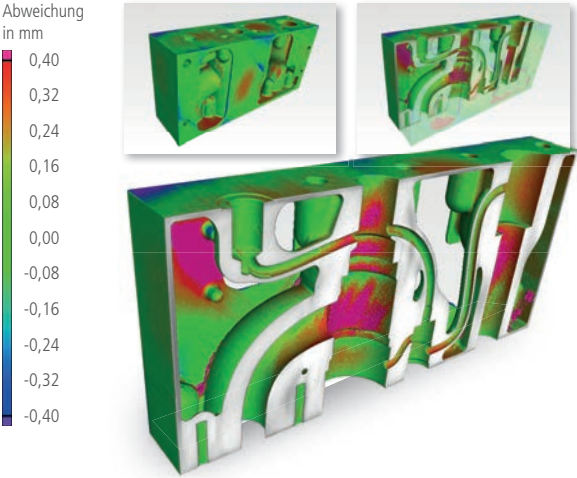

Metrology

Detailed and precise measurements of the parts geometry including inner structures.

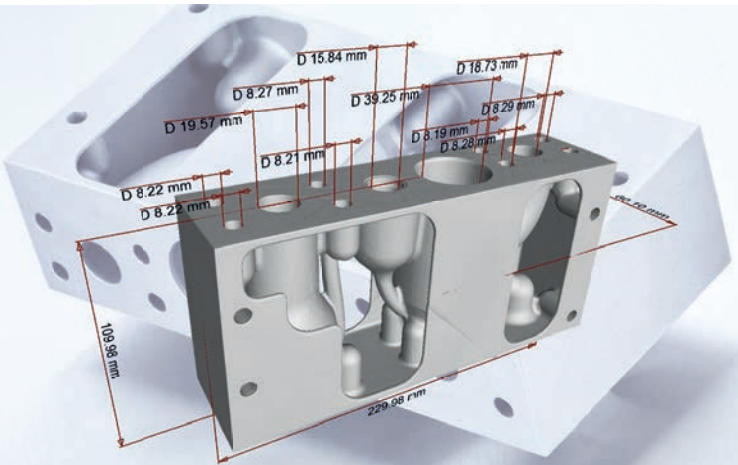

Post-processing verification

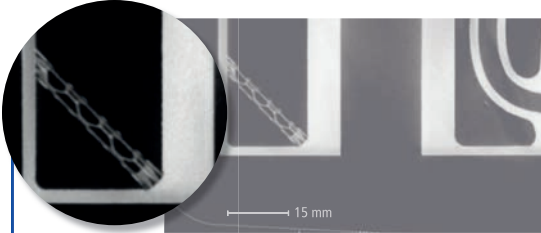

Remains of supportive structures or **powder** can be visualized non-destructively

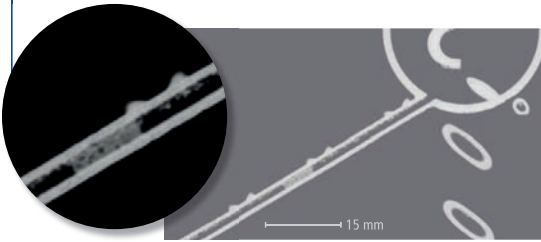

Reverse engineering

STL files (point clouds) can be generated from volumetric CT data which can then be further processed by using CAD software.



CT volumetric data

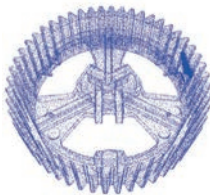

STL point cloud



CAD model

TPW Prüfzentrum

Your reliable partner for...

Non-destructive testing

- Mobile metallographic examinations
- 3D computed tomography
- Radiographic testing
- Digital radiography
- Dye penetrant testing
- Magnetic particle testing
- Ultrasonic testing
- Visual inspections
- Welding engineering
- Failure analysis

Destructive testing

incl. in house sample preparation

- Chemical analyses
- Hardness testing
- Impact testing (temperatures from -196°C)
- Corrosion testing
- Metallographic testing
- Heat treatments
- Technological testing
- Hot tensile testing up to 900°C
- Tensile testing



Deutsche
Akkreditierungsstelle
D-PL-11209-01-00

Accredited testing laboratory
D-PL-11209-01-00
DIN EN ISO/IEC 17025



Contact us!

+49 2131 6655 100

info@werkstoffpruefung.de